



AMP | AMP MCP Connector System

TE Internal #: 1-1719386-1

Automotive Terminals, Receptacle, Mating Tab Width .374 in [9.5 mm], Tab Thickness .031 in [.8 mm], 12 – 9 AWG Wire Size, AMP MCP Connector System

[View on TE.com >](#)

Terminals & Splices > Automotive Terminals > AMP MCP, RECEPTACLE AND TAB

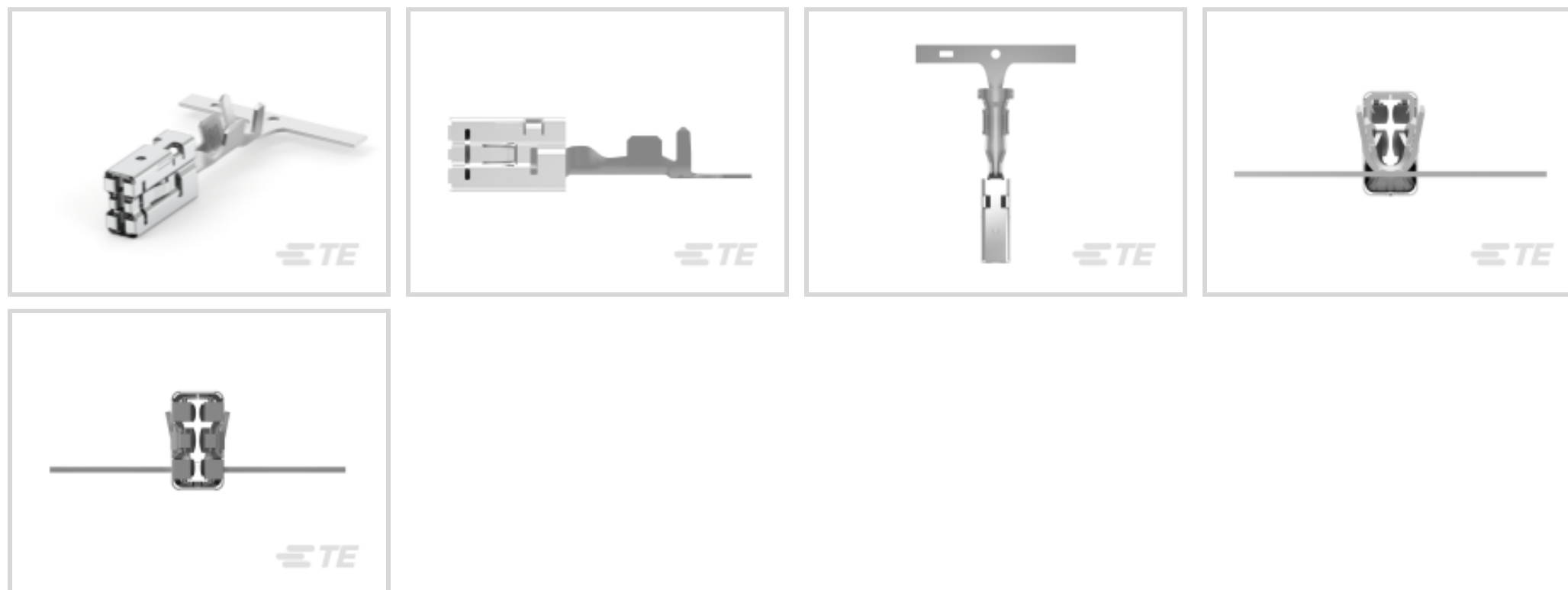

Terminal Type: **Receptacle**

Mating Tab Width: **9.5 mm [ .374 in ]**

Mating Tab Thickness: **.8 mm [ .031 in ]**

Terminal Transmits: **41 – 100 A (High Power)**

Wire Size: **12 – 9 AWG**

[All AMP MCP, RECEPTACLE AND TAB \(125\)](#)

**Features**

**Product Type Features**

Receptacle Style	180°
Sealable	No
Primary Locking Feature	Locking Lance

**Contact Features**

Contact Size	9.5mm
Contact Fabrication	Stamped & Formed
Typical Current Rating	65 A
Crimp Type	F-Crimp
Terminal Type	Receptacle
Mating Tab Width	9.5 mm[.374 in]
Mating Tab Thickness	.8 mm[.031 in]
Interface Plating	Tin (Sn)
Contact Termination Area Plating Material	Tin (Sn)



### Termination Features

Termination Method to Wire & Cable	Crimp
Product Terminates To	Wire

### Dimensions

Wire Size	3 – 6 mm <sup>2</sup>
Wire Size Search	9 AWG, 10 AWG, 11 AWG, 12 AWG
Wire Insulation Diameter	4. – 5.2 mm [.156 – .203 in]

### Usage Conditions

Insulation Option	Uninsulated
Operating Temperature (Max)	80 °C, 85 °C, 90 °C, 100 °C, 105 °C, 110 °C, 120 °C, 125 °C, 130 °C [176 °F][185 °F][194 °F][212 °F][221 °F][230 °F][248 °F][257 °F][266 °F]
Operating Temperature Range	-40 – 130 °C [-40 – 266 °F]

### Operation/Application

Compatible With Wire Base Material	Copper
------------------------------------	--------

### Industry Standards

Agency/Standard	LV214
-----------------	-------

### Packaging Features

Packaging Method	Reel
Packaging Quantity	600

### Other

Terminal Transmits	41 – 100 A (High Power)
--------------------	-------------------------

### Product Compliance

[For compliance documentation, visit the product page on TE.com>](#)

EU RoHS Directive 2011/65/EU	Compliant
EU ELV Directive 2000/53/EC	Compliant
China RoHS 2 Directive MIIT Order No 32, 2016	No Restricted Materials Above Threshold
EU REACH Regulation (EC) No. 1907/2006	Current ECHA Candidate List: JUNE 2022 (224) Candidate List Declared Against: JUNE 2022 (224) Does not contain REACH SVHC

Halogen Content	Low Halogen - Br, Cl, F, I < 900 ppm per homogenous material. Also BFR/CFR/PVC Free
Solder Process Capability	Not applicable for solder process capability

Product Compliance Disclaimer

This information is provided based on reasonable inquiry of our suppliers and represents our current actual knowledge based on the information they provided. This information is subject to change. The part numbers that TE has identified as EU RoHS compliant have a maximum concentration of 0.1% by weight in homogenous materials for lead, hexavalent chromium, mercury, PBB, PBDE, DBP, BBP, DEHP, DIBP, and 0.01% for cadmium, or qualify for an exemption to these limits as defined in the Annexes of Directive 2011/65/EU (RoHS2). Finished electrical and electronic equipment products will be CE marked as required by Directive 2011/65/EU. Components may not be CE marked. Additionally, the part numbers that TE has identified as EU ELV compliant have a maximum concentration of 0.1% by weight in homogenous materials for lead, hexavalent chromium, and mercury, and 0.01% for cadmium, or qualify for an exemption to these limits as defined in the Annexes of Directive 2000/53/EC (ELV). Regarding the REACH Regulation, the information TE provides on SVHC in articles for this part number is based on the latest European Chemicals Agency (ECHA) 'Guidance on requirements for substances in articles' posted at this URL: <https://echa.europa.eu/guidance-documents/guidance-on-reach>

### Compatible Parts



TE Part # CAT-AM705-CH8173  
AMP MCP Unsealed Connector Housings



TE Part # 2177213-1  
TAB 9.5x0.8 CONTACT CS SRC Sn

### Also in the Series | AMP MCP Connector System



Automotive Connector Caps & Covers (24)

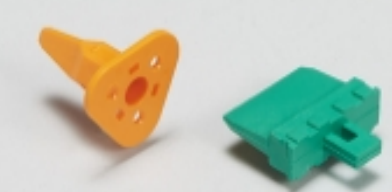

Automotive Connector Locks & Position Assurance(7)



Automotive Housings(352)



Automotive Seals & Cavity Plugs(6)



Automotive Terminals(125)



Insertion & Extraction Tools(13)



Other Automotive Connector Accessories(2)



PCB Headers & Receptacles(29)



## Documents

### Product Drawings

#### AMP MCP 9.5, CONTACT

English

---

### CAD Files

#### Customer View Model

##### ENG\_CVM\_CVM\_1-1719386-1\_B.2d\_dxf.zip

English

#### 3D PDF

3D

#### Customer View Model

##### ENG\_CVM\_CVM\_1-1719386-1\_B.3d\_igs.zip

English

#### Customer View Model

##### ENG\_CVM\_CVM\_1-1719386-1\_B.3d\_stp.zip

English

By downloading the CAD file I accept and agree to the [Terms and Conditions](#) of use.

---

### Product Specifications

#### Application Specification

German

#### Application Specification

German